

Troubleshooting Tips

***If you notice something out of the ordinary with the look or performance of your shade, please take a photograph/video of the concern, and advise our Customer Service team. ***

I cannot set the upper limit on my shade	<ul style="list-style-type: none"> Qfree shades do not have the ability to adjust the upper limit..
My shade has little tension and will not roll up all of the way	<ul style="list-style-type: none"> Apply pre-winds using the Pre-Winding Instructions below.
My shade is raising too fast	<ul style="list-style-type: none"> Remove pre-winds using the instructions below.

Pre-winding Instructions

1. Remove the shade from the bracket at the end of the shade that has the power spring(s). You can leave the shade attached to the bracket at the other end.
2. Hook the prewind wrench around the shaft coming out of the roller shade and rotate the wrench in the opposite direction that the material comes off of the shade.
3. Remove the shade from the bracket at the end of the shade that has the power spring(s). You can leave the shade attached to the bracket at the other end.
4. Hook the prewind wrench around the shaft coming out of the roller shade and rotate the wrench in the opposite direction that the material comes off of the shade.

Removing Pre-winds

1. Between the shade and the bracket, hook the wrench around the shaft coming out of the shade.
2. While firmly grasping the wrench lift the shade up and out of the bracket.
3. Allow the wrench to rotate until the tension is off of the wrench. Be careful not to let the wrench go.
4. Remove the wrench and re-seat the shade back into the bracket.



Qfree Installation Instructions

IMPORTANT

Installing a Qfree Roller Shade

Find the shades mounting style on the order form (top, back or side). This is especially important when using universal brackets versus fascia brackets. Then determine the roll type. Standard roll shades will roll off the back of the shade, and reverse roll will roll off of the front. Proceed to follow the below instructions once this information is determined.

NOTE: Upper limits are not adjustable on the Qfree.

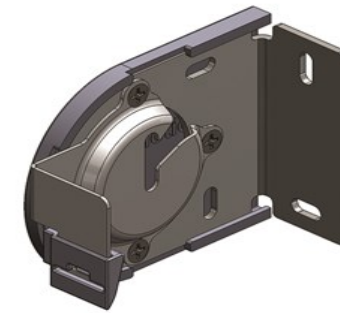

Universal Bracket



Fascia Bracket

Tools required

- Pencil
- Power Drill
- Level
- (4) Wall Anchors
- 3/32" (2mm) Drill Bit
- Screw Driver
- (4) #6 (M3.5) Screws
- Measuring Tape

Inside Mount

Standard/Reverse Roll

STEP 1 Position the bracket flush against the window and head jamb. Bracket mounting depth of at least 2" is recommended. Mark the slotted hole. Repeat on window's opposite side.

STEP 2 Use a 3/32" (2mm) drill bit to drill a pilot hole at the bottom of your marks.



STEP 3 Use a screw driver or power drill to install brackets with screws. Repeat on window's opposite side.

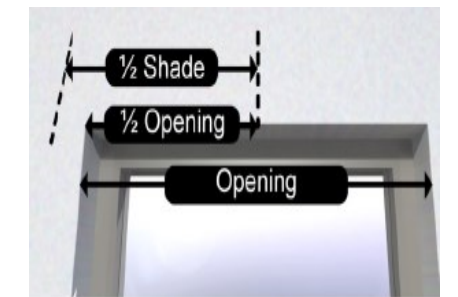

STEP 2 Align bracket with your mark 1/2" above your window opening. Mark the slotted hole. Drill pilot hole at the bottom of the mark. Repeat on opposite side.

STEP 3 Use a screw driver or power drill to install bracket with a screw. Repeat on window's opposite side.

Follow the above instructions for ceiling mount applications.

Outside Mount

Standard/Reverse Roll

STEP 1 Measure and mark half of the window width. Measure and mark half of the shades bracket to bracket width on each side of window.

(Insert picture)

Installing Your Shade

STEP 1 Hang the shade inside of the bracket in the correct roll direction.

STEP 2 Safely adjust the shade to be level. Use a level to ensure the shade is sitting level, and note if the brackets or shade should be adjusted accordingly.

STEP 3 If shade is level, remove the shade and drill your final holes to secure each bracket with a second screw.

STEP 4 You can now install your shade.



Preloading

STEP 1 Preloading is necessary for the shade to roll up. With the shade in the brackets, pull it down 12 inches. The mechanism inside will lock position into position, allowing the shade to hang.

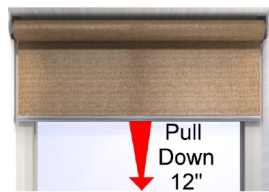

STEP 2 Disengage shade from brackets and manually roll the fabric onto the tube.

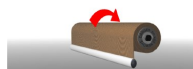

STEP 3 Re-install the shade into the brackets.

Universal Brackets

IMPORTANT

Universal Brackets are delivered pre-configured for the intended installation type. Reconfiguring the brackets is not recommended. The following information is to aid you in understanding how to install the brackets for each configuration.

TOP MOUNT - STANDARD ROLL

The Rubber Stopper is on the opening's window side. The Spindle Slot opens toward the room.

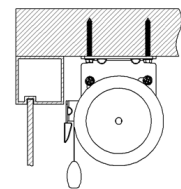

Spindle Slot

Rubber Stopper BACK MOUNT - STANDARD ROLL

The Rubber Stopper is on the opening's window side. The Spindle Slot opens toward the room. Back Mounts are typically used for outside mount shades.

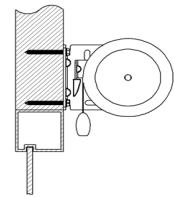

Spindle Slot

Rubber Stopper

SIDE MOUNT - STANDARD ROLL

The Rubber Stopper is on the opening's window side. The Spindle Slot opens toward the room.

MOUNT - REVERSE ROLL

The Rubber Stopper is on the opening's room side.

The Spindle Slot opens toward the window.

Leave at LEAST 1" between the shallowest point in the opening and the bracket to allow Spindle placement.

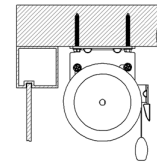

Spindle Slot

Rubber Stopper BACK MOUNT - REVERSE ROLL

The Rubber Stopper is on the opening's room side. The Spindle Slot opens toward the window.

Back Mounts are typically used for outside mount shades.

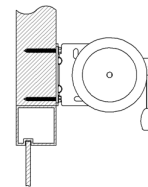

Spindle Slot

Rubber Stopper SIDE MOUNT - REVERSE ROLL

The Rubber Stopper is on the opening's room side.

The Spindle Slot opens toward the window.

Leave at LEAST 1" between the shallowest point in the opening and the bracket to allow Spindle placement.

Fascia Brackets

TOP MOUNT - STANDARD ROLL

The Rubber Stopper is on the opening's window side. The Spindle Slot opens toward the room.

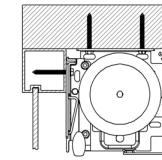

Spindle Slot

Rubber Stopper

BACK MOUNT -

STANDARD ROLL

The Rubber Stopper is on the opening's window side. The Spindle Slot opens toward the room. Back Mounts are typically used for outside mount shades.

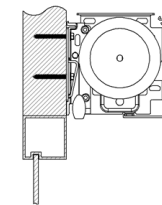

Spindle Slot

Rubber Stopper

SIDE MOUNT - STANDARD ROLL

The Rubber Stopper is on the opening's window side. The Spindle Slot opens toward the room.

MOUNT - REVERSE ROLL

The Rubber Stopper is on the opening's room side.

The Spindle Slot opens toward the window.

Leave at LEAST 1" between the shallowest point in the opening and the bracket to allow Spindle placement.

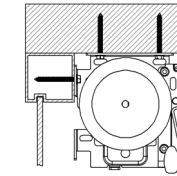

Spindle Slot

Rubber Stopper

BACK MOUNT - REVERSE ROLL

The Rubber Stopper is on the opening's room side. The Spindle Slot opens toward the window.

Back Mounts are typically used for outside mount shades.

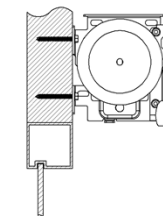

Spindle Slot

Rubber Stopper

SIDE MOUNT - REVERSE ROLL

The Rubber Stopper is on the opening's room side.

The Spindle Slot opens toward the window.

Leave at LEAST 1" between the shallowest point in the opening and the bracket to allow Spindle placement.

Pocket Installation

TOP MOUNT - STANDARD ROLL

The Rubber Stopper is on the opening's window side. The Spindle Slot opens toward the room.

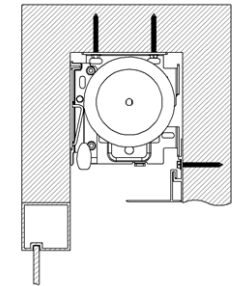

MOUNT - REVERSE ROLL

The Rubber Stopper is on the opening's room side.

The Spindle Slot opens toward the window.

Leave at LEAST 1" between the shallowest point in the opening and the bracket to allow Spindle placement.

