

Qmotion® Automated Coupled Roller Shade Instruction Manual



Qlink™

Coupled Shade System
2.6" and 3.3" Bracket
Standard Roll
Inside or Outside Mount

WARNING:

Read and understand all instructions to avoid damage or injury. Work safely. Product is not intended for the do-it-yourselfer. Solicit professional installation help before attempting to install.

1. Tools Needed

- | | |
|-----------------------------|-------------------------|
| A. Measuring Tape | G. 1/8" Drill Bit |
| B. Pencil | H. 1/4" Nut Driver |
| C. String Level | I. Driver Extension |
| D. Framing Level | J. 10mm Open End Wrench |
| E. #2 Phillips Screw Driver | K. Pre-wind Wrench* |
| F. Electric Screw Driver | L. Spanner Wrench |

*See Prewind Instructions

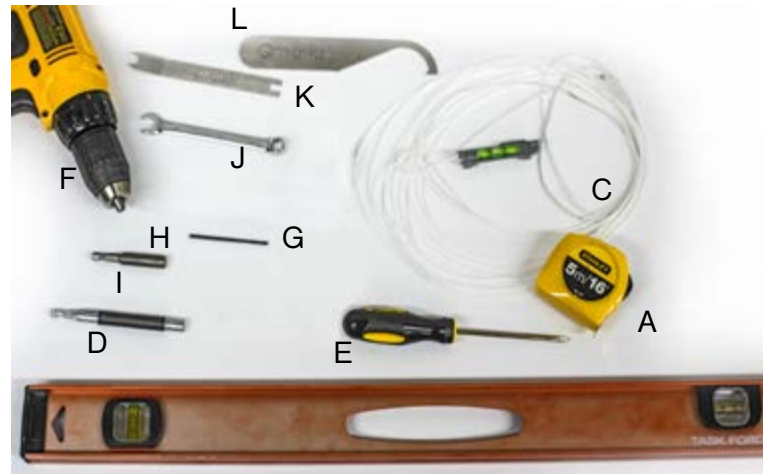

Fig. 1 - Tools

2. Measure

Measure the opening to be covered using Measuring Tape (A). Ensure that the assembly will fit by totalling all shade widths (found on the packing list).

If the opening is slightly too large, divide the difference between the opening width and overall shade width by two, then offset your first bracket by that amount.

If the opening is too small and the shade is inside mount, please contact Qmotion Customer Service.

3. Install End Brackets

(Note: There are three bracket types: 2.6 Universal, 3.3 Unversal, 3.3 Fascia; Two mounting applications: Back and Top; Two roll directions: Standard, Reverse. Your package should come with specific mounting instructions depending on your system.)

3-1. Measure from jamb to jamb to find "Opening Width" as in Step 2.

3-2. The Center measurement is equal to the "Opening Width" divided by 2. Use this measurement to find and mark Center.

3-3. Use the Overall Width of the assembly (the total of all "Width" dimensions on the packing labels, this can also be found on the order confirmation sheet) as the "Overall Width".

3-4. Divide the "Overall Width" by 2. Measure this distance from the Center to each side of the window. This is where the outside edge of each bracket will sit.

3-5. **Outside Mount:** Measure 1/2" above the window opening. This is where the End Bracket's bottom edge will rest.

Inside Mount: Refer to application specific instructions.

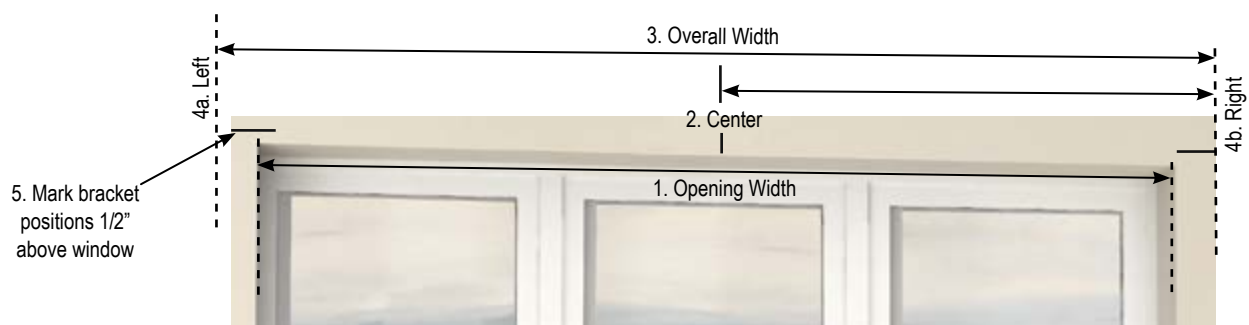

3. Install End Brackets (Continued)

3-6. Temporarily place each End Bracket and mark its screw slots.

3-7. Pre-drill the marked slots using a 3/32" drill bit. Ensure that screws will secure into structure, or use appropriate wall anchors (not included).

3-8. Mount End Brackets using supplied screws. For all brackets, installer is to ensure adequate substrate material is available to hold screws securely.

4. Package Identification

Use the colored labels on the shade packaging to determine their mounting position in the assembly.



Fig. 4 - Labels

5. Qlink System Layout

Lay out the shades prior to installation. For standard roll applications put the shade labeled "Sprung" **Pink label** on the right side of the opening. Put the shade labeled "Motor" **Green label** on the left end of the opening. For reverse roll the shade installation is opposite. **Pink label** is left and the **Green label** is right.

Place the remaining shades with **Yellow labels** between the two end shades according to their size and the order sheet. **Because any of the shade widths can vary, ensure that each shade is properly located! The numbers on the colored labels are in sequence of how the Qlink shade assembly was tested in the factory.**

Always begin installation on the **Pink labeled** "sprung shade".



Fig. 5 - Layout

6. Measure for Coupler Brackets

When measuring for Bracket placement, use the "Width" dimension on the shade packing label.

If measuring from an End Bracket, measure from the outer edge of the End Bracket to the center of the Coupler Bracket.

If measuring from a Coupler Bracket, measure from the center of one to the center of the next.

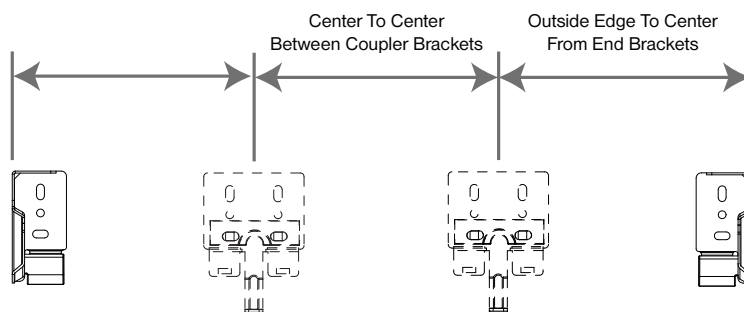

Fig. 6 - Bracket Measurement

Note: Depending on application, brackets may not all mount at the same height. For best performance spindle axes must be aligned.

7. Install Coupler Brackets

Your package should come with specific mounting instruction details depending on your application. Refer to this instruction sheet to determine the height of the coupler bracket.

Center Coupler Bracket on mark from previous step. Pre-drill the four screw holes. Drive screws in every hole.

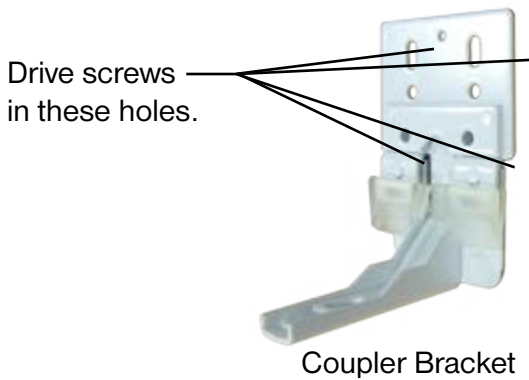

2.6" Bracket Shown (Note: there are three bracket types available; 2.6 Universal, 3.3 Universal, and 3.3 Fascia)

Fig. 7 - Coupler Bracket and End Bracket

8. Set up the Coupler Assembly

Ensure that the Disk Nut sits flush with end of the screw post (Fig. 8). If the screw sticks out, the Coupler Assembly may not fit into the Coupler Bracket.

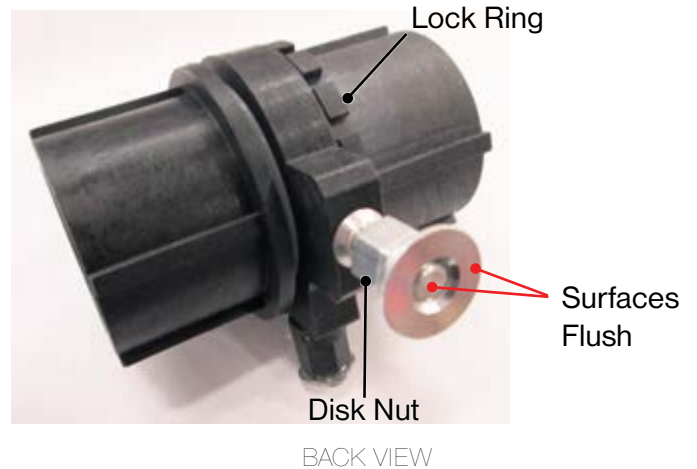
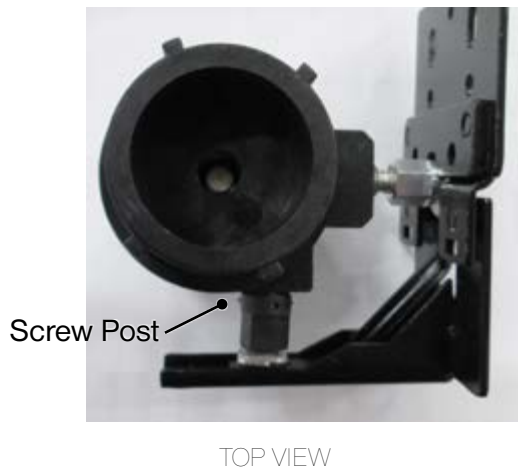
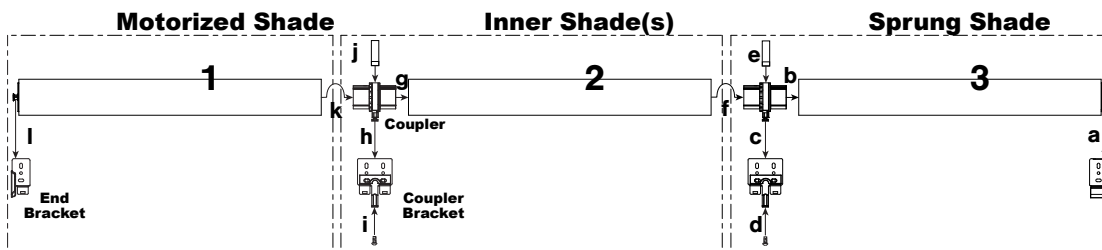

Fig. 8 - Coupler Assembly

9. Install Shades

Review the Installation Schematic (Fig. 10) and understand the process. Installation begins on the sprung side to the motor side. Each action is numbered in order. The arrows show where each item mates into the previous one.

Note: For Fascia Application install Motorized Shade first, then Inner Shade(s) and then Sprung.



9-a. Insert Sprung Shade spindle into End Bracket

Note: Prewinds are made on the Sprung End.

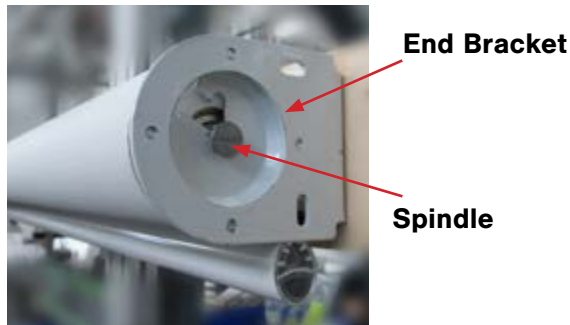

Right end of Sprung Shade

9-b. Insert Coupler Assembly into Sprung Shade

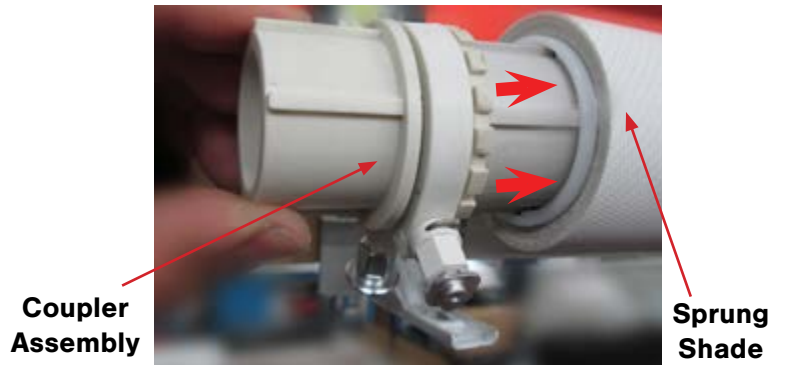

Left end of Sprung Shade

9-c. Mount Coupler Assembly on Coupler Bracket

Ensure coupler disk nut is completely engaged into circular bracket plate.

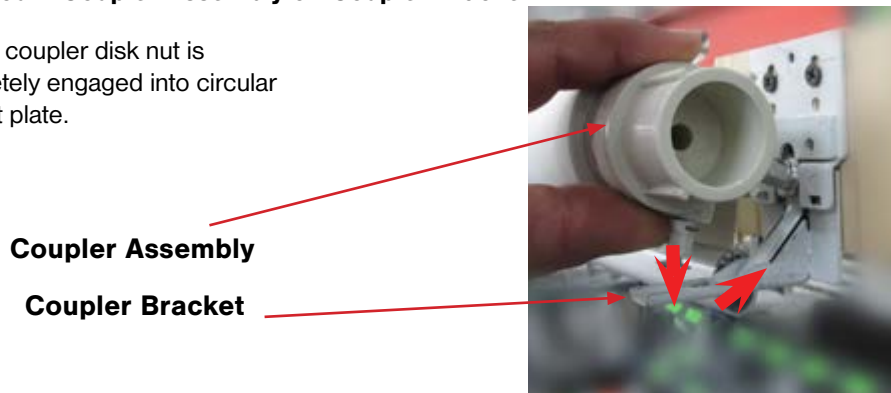

9-d. Secure Coupler Assembly to Coupler Bracket

Install screw into the Coupler Assembly, through the hole in the Coupler Bracket's arm.

Ensure that the Oblong Shoulder rests aligned in the slot. (See bottom view.)

Screw



9-e. Install Safety Strap onto Coupler Bracket

WARNING! You must install the safety straps on all coupler brackets one at a time in succession during the installation process to reduce the risks of personal injury and possible damage to the shade.

Do not wait until the end to install safety straps.

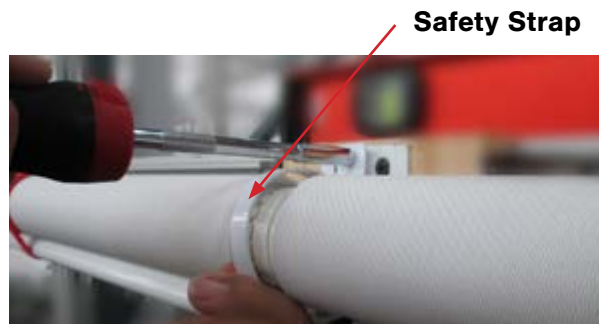

9-f. Install Inner Shade onto secured Coupler Assembly

If you do not have an inner section advance to 10-k.

The roller tube is designed to guide the couple cone into position, although long shades may require two people to install safely. Align all shades to couplers the same way, **always aligning hem bars in the up position.** Unroll or roll up connecting shades to align hem bars. Fine adjustments can be made later in Step 12.

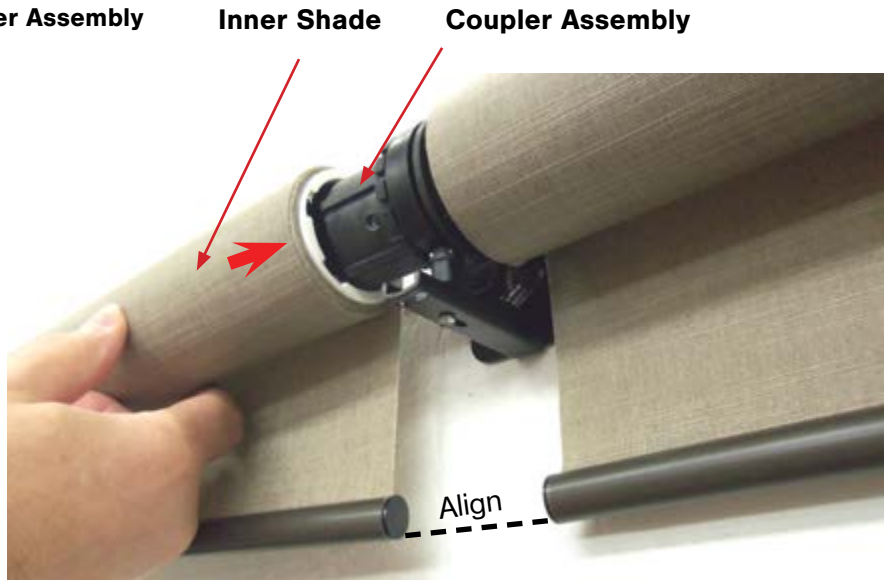

Right end of Inner Shade

9-g. Repeat Steps 9-b to 9-f as needed, then install Motor Shade onto secured Coupler Assembly

9-h. Insert Sprung Shade spindle into End Bracket

Note: Prewinds are made on the Sprung End.

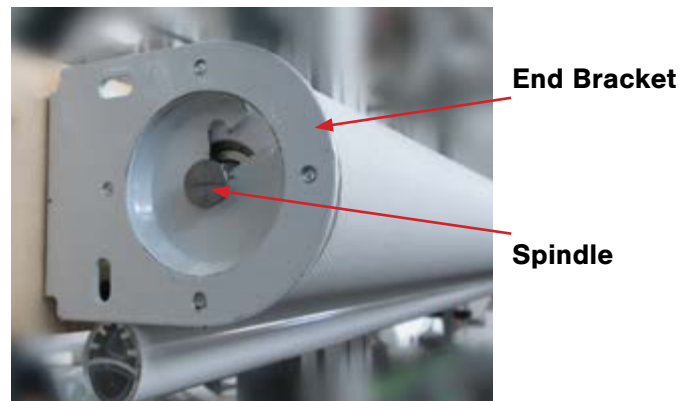

Right end of Sprung Shade

10. Adjust Hem Bars

Starting at the Sprung Shade and moving left, adjust the hem bars to match each previous shade by holding the shade on your right with your right hand and the shade on your left with your left hand and rotating the left shade to match the shade on the right. Use the supplied Spanner Wrench (L) tightening Lock Ring when hem bar is located at the desired position. Tighten the Lock Ring by turning up on the Spanner Wrench. Loosen the Lock Ring by turning the Spanner Wrench down.

Note: Because of fabric thickness tolerances, the hem bar position may vary at locations other than where the hem bar was set. To correct this mismatch: Add tape to the tube on the longer shades until desired length is achieved for each shade.

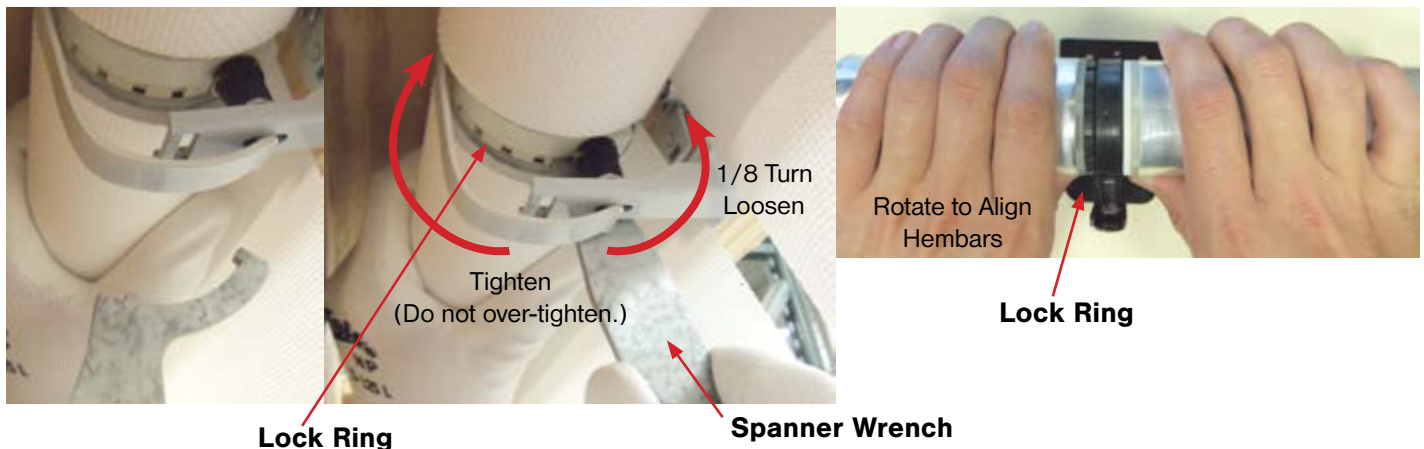

11. Activate and Program Shade

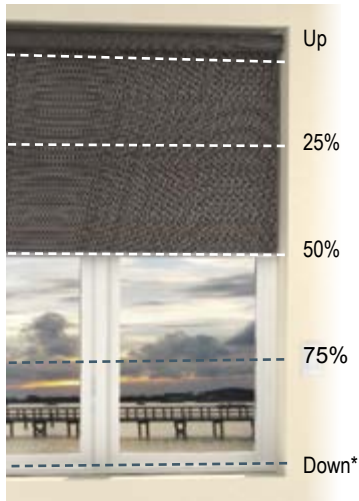

*Typical user-defined Down position shown

Your shade has factory preset position settings. To activate the shade and set a new Down position:

1. Tug hem bar (D) downward at least 18-20 inches to start the activation process. Perform step 2 within 1 minute or shade deactivates and returns to Up position automatically.
2. Press and hold UP button for approximately 5 seconds until shade begins to move up. Wait for shade to stop in Up position. This remote is now learned to the shade.
3. Press DOWN button to send shade to the factory default Down position. To reprogram this Down position, follow steps 4 through 7.
4. While shade is in factory preset Down position, press and hold DOWN button for approximately 5 seconds. Shade will move up slightly, then back down slightly and stop. Release the DOWN button.
5. Pull the hem bar to the desired Down position. The shade is now in Down Position Learn Mode.
6. When satisfied with Down position, press and hold the DOWN button for approximately 5 seconds until shade begins to move up. The shade is no longer in Down Position Learn Mode.
7. The shade will continue to move up until it reaches the brackets. After shade stops it is programmed and ready to use.

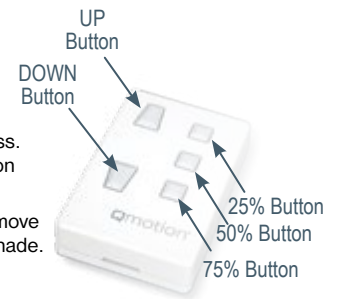

12. Height and Depth Adjustments

If the shade edges are not parallel, the Coupler Assembly can be adjusted. If the gap widens at the bottom, adjust the Coupler Assembly upward. If the gap closes at the bottom, adjust the Coupler Assembly downward.

Adjust Coupler Assembly height as needed using 3/8" or 10mm wrench (J). **Note:** Couplers may be adjusted 2.5 turns up or down from nominal. Couplers are set to nominal at factory. If more adjustment is needed, moving brackets up or down may be necessary. **Initial leveling is critical.**

Turning left adjusts the Coupler Assembly downward.
Turning right adjusts the Coupler Assembly upward.

Adjust the depth as needed using 3/8" or 10mm wrench.
Note: The maximum number of turns is five.
(2.5 up and 2.5 down)

Turning left adjusts the Coupler Assembly toward the wall.
Turning right adjusts the Coupler Assembly into the room.

Learn more advanced programming at <http://qmotionshades.com>

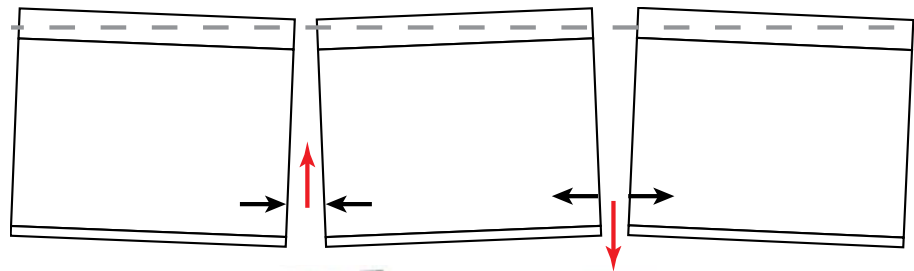

Coupler Assembly Vertical Adjustment Nut

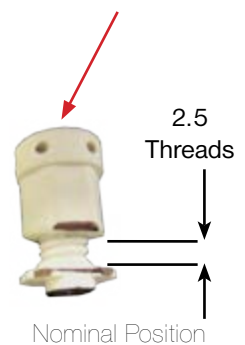

13. Finish Installation

Ensure that all safety straps are installed on all coupler brackets. Ensure that all coupler Lock Rings are tightened securely.

Changing the Batteries

1. Using the remote, move the shade to the Down position. If the shade's batteries are completely depleted, you may skip to step 3.
2. Tug the shade past the Down position. The shade will then automatically reverse direction and move to the 75% position.
3. Carefully pull the hem bar down in one continuous motion until the battery window is exposed. Ensure Manual Operation is deactivated by tugging the shade or turning the tube. If deactivated, remove the battery cover to expose battery access.
4. Replace all batteries with fresh D-Cell alkaline batteries. Always use the same brand and manufacturing date. Orient all batteries with the positive end as shown.
5. Reinstall the battery cover flush with the shade tube. Press any button. The shade moves to the Up position. The shade will now resume normal operation. All positions are recovered from memory.

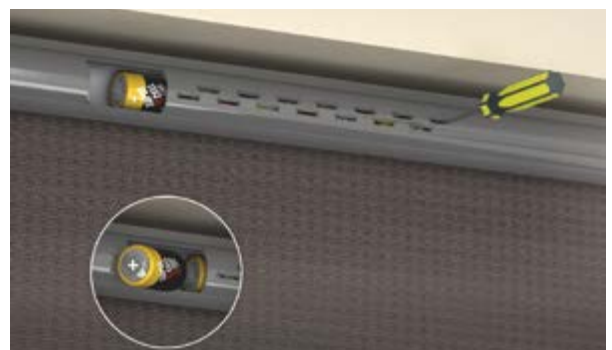

Symptom	Problem	Solution
When shade is in the UP position, fabric hangs over one end of the shade and may interfere with brackets	Telescoping fabric.	Identify the direction of the overhang. Follow steps 1-3 of the battery changing procedure to expose the shade tube. Apply a 3" x 3/4" piece of masking tape horizontally on the shade tube on the side where fabric overhangs tube. Press any button on the remote. Verify if the telescoping has been corrected and repeat this process as needed.
Shade width is too narrow to hang in brackets	Brackets too far apart.	Measure shade fabric width. Adjust outside of bracket to outside of bracket dimension to equal fabric width + 1". Reinstall using shims to level. Properly secure brackets.
Shade has fresh batteries and the motor can be heard, but the shade is moving slowly or not at all.	Shade and brackets interfere with each other.	Remove the shade from the brackets and adjust the position and mounting angle of the brackets to eliminate interference. Re-install the shade.
Shade is unresponsive to a specific button.	Stuck in a specific position's Learn Mode.	Wait 1 minute for the shade to automatically exit Learn Mode. All other buttons except for this specific position's button will work. However, while in Down position Learn Mode, pressing the DOWN button will stop the shade if moving up.

If you still experience difficulties, please call toll-free 1-877-849-6070.



www.qmotionshades.com



MODEL: HRH-WS02
WALL STATION TRANSMITTER
FCC ID: X6P-0003300
IC: 8832A-0003300

MODEL: HRH-PT05
PORTABLE TRANSMITTER
FCC ID: X6P-0003186B
IC: 8832A-0003186B

MODEL: QT-2
ROLLER SHADE
CAN RSS-GEN/CNR-GEN

MODEL: QTL74
QMOTION REMOTE
FCC ID: X6P-HR110845
IC: 8832A-HR110845

This device complies with Part 15 of the FCC Rules. Operation is subject to the following two conditions:

- 1) This device may not cause harmful interference, and
- 2) this device must accept any interference received, including interference that may cause undesired operation.

Warning: Changes or modifications to this device not expressly approved by HomeRun Holdings could void the user's authority to operate the equipment.

"NOTE: This equipment has been tested and found to comply with the limits for a Class B digital device, pursuant to Part 15 of the FCC Rules. These limits are designed to provide reasonable protection against harmful interference in a residential installation.

This equipment generates, uses, and can radiate radio frequency energy and, if not installed and used in accordance with the instructions, may cause harmful interference to radio communications. However, there is no guarantee that interference will not occur in a particular installation. If this equipment does cause harmful interference to radio or television reception, which can be determined by turning the equipment off and on, the user is encouraged to try to correct the interference by one or more of the following measures: • Reorient or relocate the receiving antenna. • Increase the separation between the equipment and receiver. • Connect the equipment into an outlet on a circuit different from that to which the receiver is connected. • Consult the dealer or an experienced radio/TV technician for help."

The term "IC:" before the radio certification number only signifies that Industry Canada technical specifications were met.

This Class B digital apparatus meets all requirements of the Canadian Interference Causing Equipment Regulations. Operation is subject to the following two conditions:

- (1) this device may not cause harmful interference, and
- (2) this device must accept any interference received, including interference that may cause undesired operation.

Cet appareillage numérique de la classe B répond à toutes les exigences de l'interférence canadienne causant des règlements d'équipement. L'opération est sujette aux deux conditions suivantes: (1) ce dispositif peut ne pas causer l'interférence nocive, et (2) ce dispositif doit accepter n'importe quelle interférence reçue, y compris l'interférence qui peut causer l'opération peu désirée.

Do not operate at temperatures below 32° F or above 130° F. End user must ensure that shade being used is fire resistant. Keep transmitter away from children. Periodically examine assembly and brackets for signs of wear and discontinue use if repair is necessary. The controller and transmitter assemblies contain no serviceable parts.